

epiQ

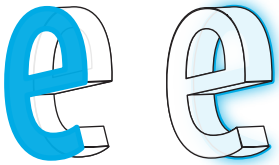

3-9 cm
channel letters



12V
DC

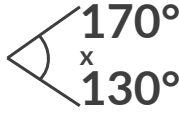

IP
65

5
YEAR
warranty



- **167 lm/W** luminous efficacy
- **energy** saving
- **small** size
- perfect for **small letters and narrow shaped objects**
- **indoor / outdoor** use
- chain of **50 pcs**



DIMENSIONS

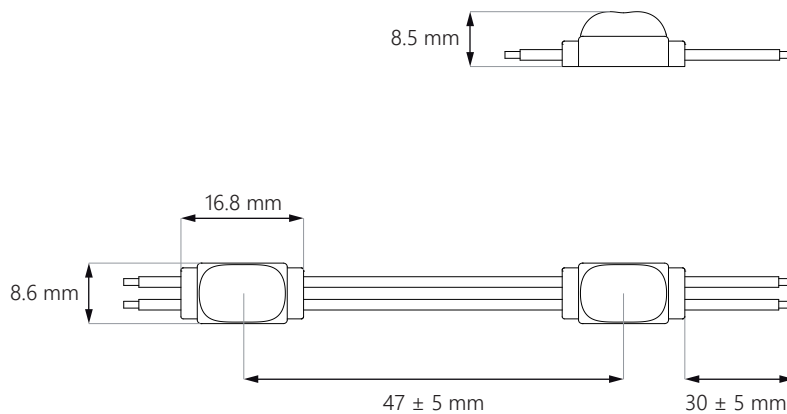



CONNECTION DIAGRAM

one-side power input: **max 50 pcs**

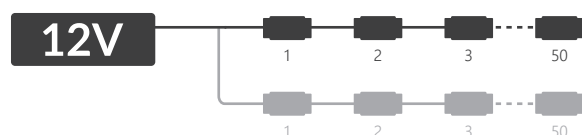

two-side power input: **max 100 pcs**

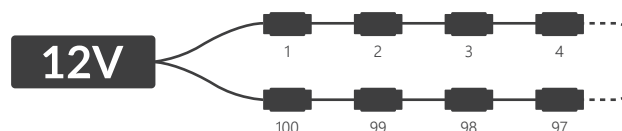

TECHNICAL SPECIFICATION

Input voltage	12V DC
Nominal power usage per module	0.24 W
Nominal power usage per chain	12 W

Colour rendering index	≥82
Beam angle	170° x 130°
Current stabilization	NO
Dimmable	YES

Module dimensions (L x W x D)	16.8 x 8.6 x 8.5 mm
Cable length	30 ± 5 mm
Module length including cable	47 mm
Chain length	2.35 m
No. of modules in 1 m	21.28 pcs

Lifespan	~50000 h
Working temperature	-25°C ÷ +55°C
IP Rating	IP65
Compliance with	CE / RoHS / WEEE / UL listed
Warranty	5 years

CCT / LIGHT COLOUR*

Abbreviation	Light colour	CCT
WW	warm white	~3000K
NW	neutral white	~4000K
PW	pure white	~5000K
WH	daily white	~6500K
WS	white	~7200K
CW	cold white	~10000K
BL	blue	460-470 nm
GR	green	520-530 nm
YL	yellow	575-585 nm
RD	red	620-630 nm

* ask our sales team for details of available colours

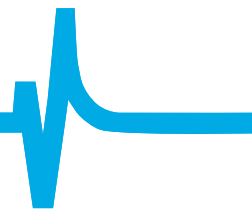

APPLICATION

best for channel letters and lightboxes with a depth of **3-9 cm**

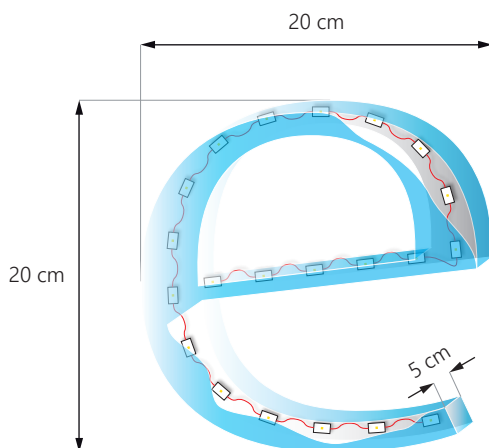

Area: **0.04 m²**
 No. of modules: **21 pcs**
 Lumen output: **840 lm**
 Power usage: **5.04 W**

NOTE: the exact number of modules depends on the used materials and the effect we want to achieve.

PACKING INFORMATION

	Chain	Bag	Box
Quantity	50 pcs	500 pcs	6000 pcs
Gross weight	0,1 kg	1 kg	12 kg

DOWNLOAD AREA

LED Module installation guide

<https://www.epiled.pl/download/led-module-installation-guide.pdf>

EU Declaration of Conformity

<https://www.epiled.pl/download/deklaracje/eu-declaration-of-conformity-led-modules.pdf>